

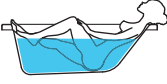

 ~ 230 l	 ~ 160 l	 220-240 V - 50/60 Hz 6/12 (A) A 1,2 / 2,5 (kW)	 180x80x74 cm ~ 85 kg	 ~ 60 kg	 ~ 245 kg/m <sup>2</sup>
---	--	---	--	---	--

SHARP 70  
170x70



(\*) con sistema di mantenimento della temperatura dell'acqua - with water temperature control system - avec système de maintien de la température de l'eau  
mit system zur Erhaltung der Wassertemperatur - con sistema de mantenimiento de la temperatura del agua - с система поддержания температуры воды

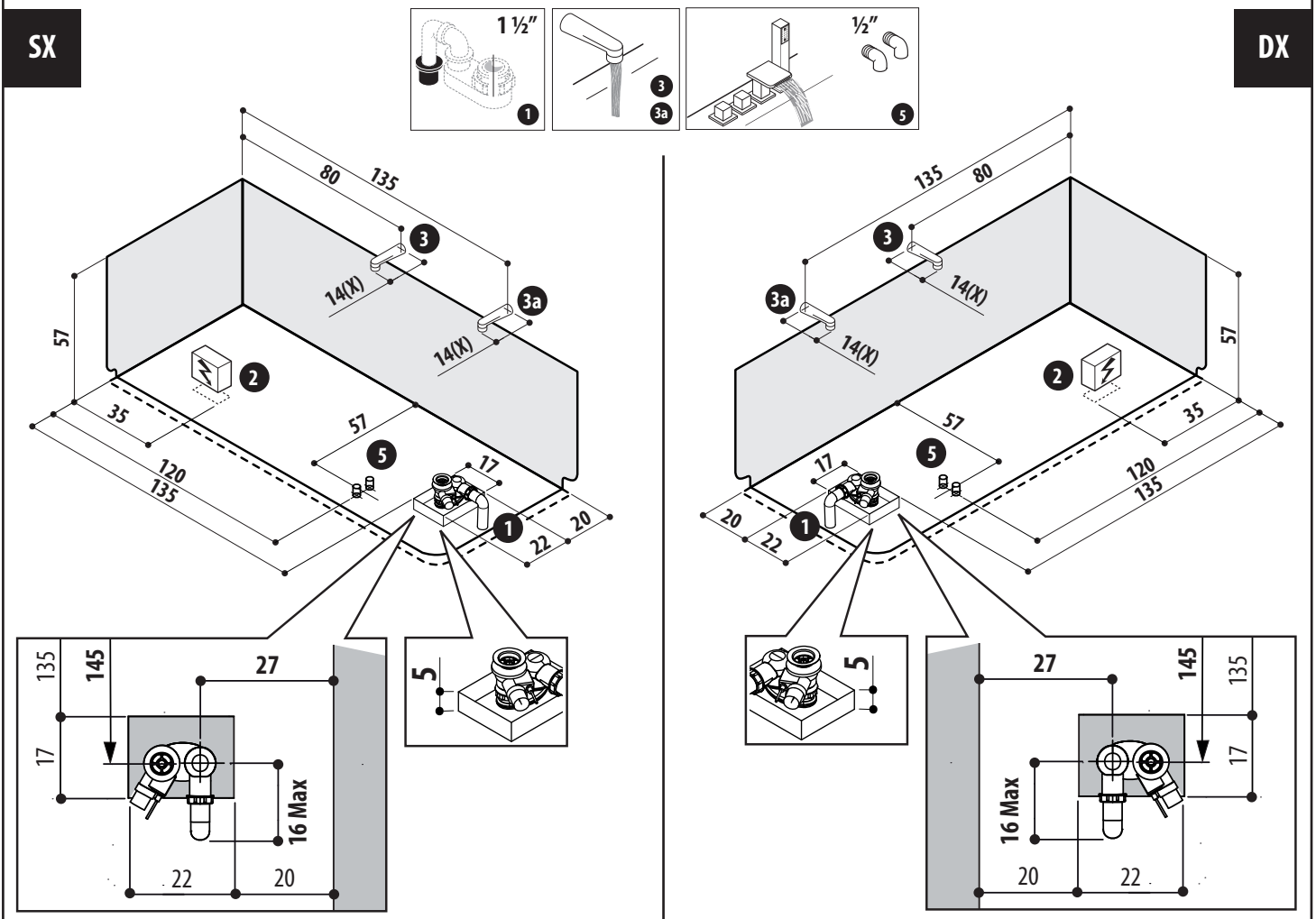
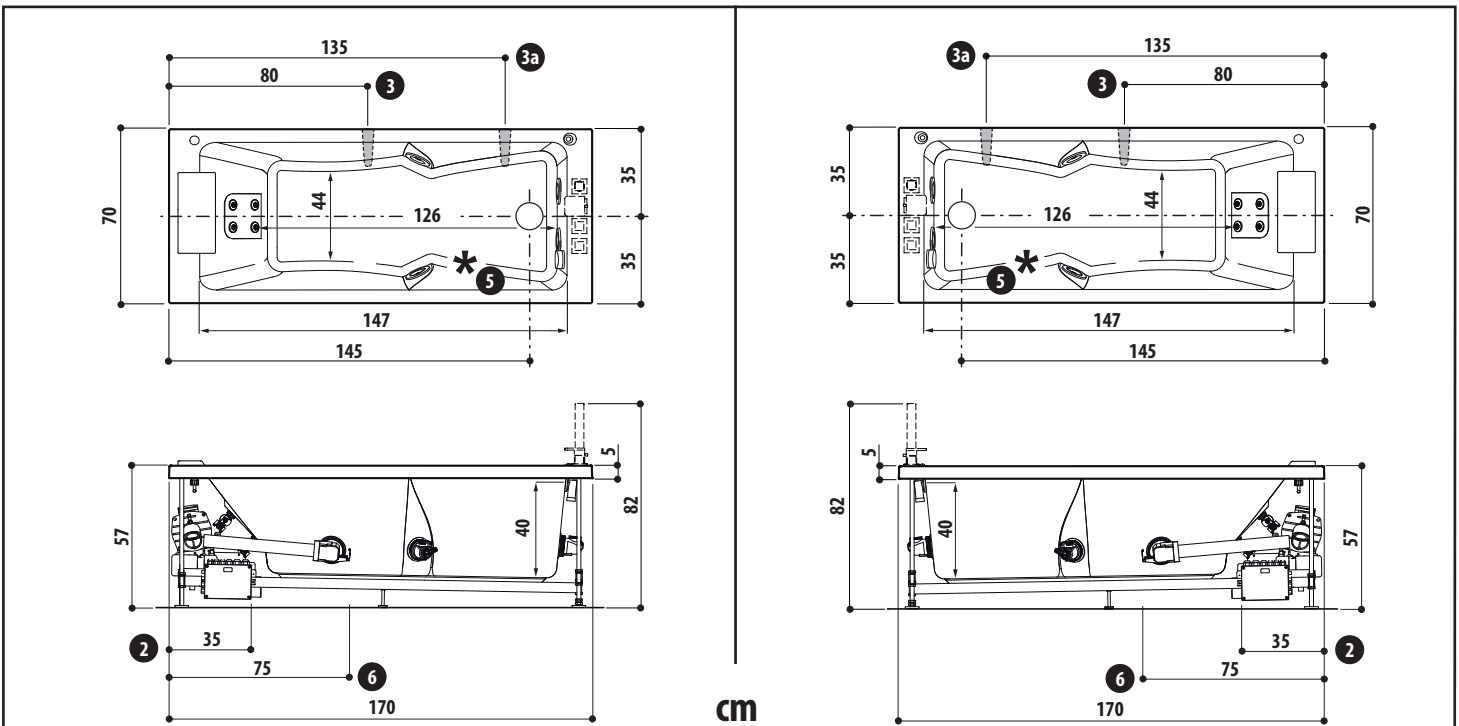

ALLEGARE IL TESTO DI PREINSTALLAZIONE - ADD TO THIS SHEET THE PREINSTALLATION INSTRUCTIONS - FICHE À ASSOCIER AU TEXT DE PRE-INSTALLATION - DIESES DATENBLATT MUSS VOM VORINSTALLATIONS TEXT - FICHA A UNIRSE AL TEXTO DE PREINSTALACIÓN  
ПРИЛОЖИТЬ К ПРЕВАРИТЕЛЬНОЙ ТЕКСТАМ