

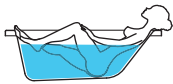







 ~ 340 l	 ~ 260 l	 220-240 V 50/60 Hz 6 A 1,2 kW	 191x100x80 cm ~ 120 kg	 ~ 80 kg	 ~ 259 kg/m ²
---	--	---	--	---	--

j-sha mi
dx

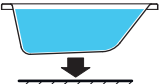
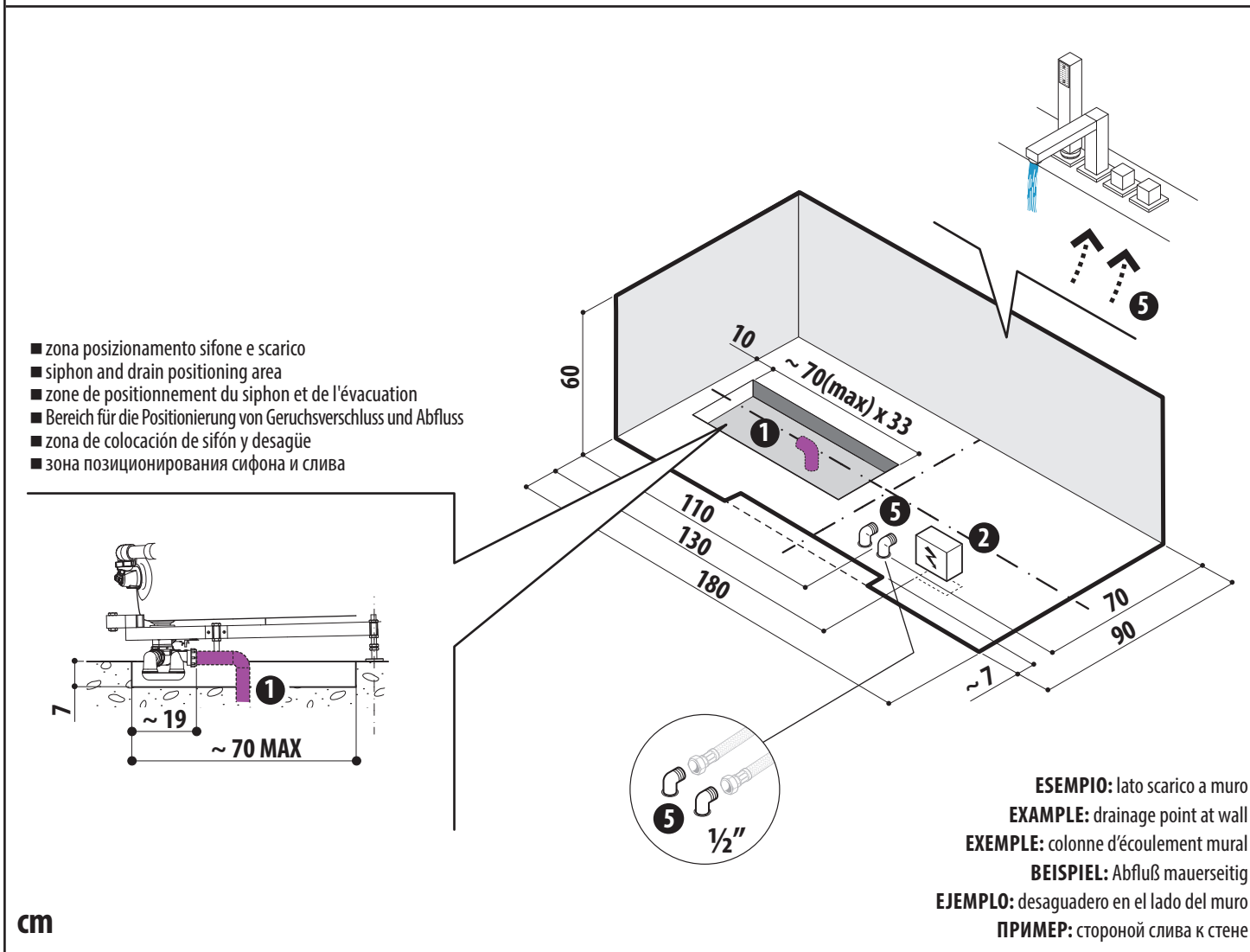
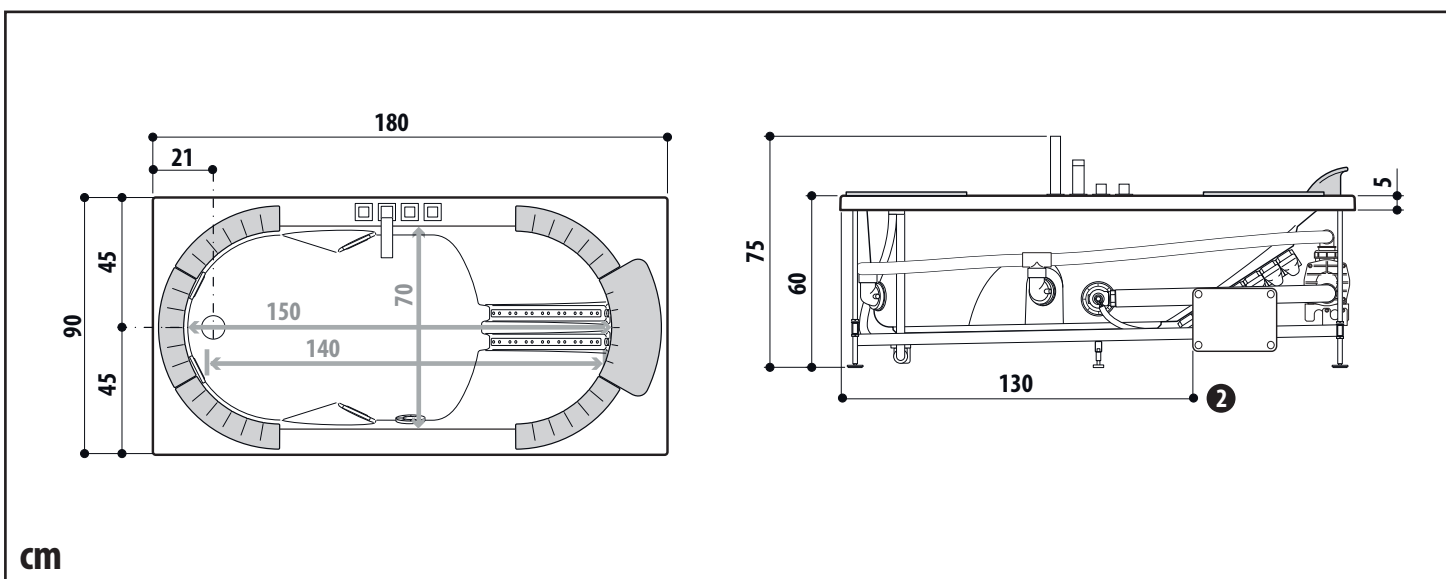

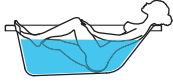
 **ALLEGARE IL TESTO DI PREINSTALLAZIONE - ADD TO THIS SHEET THE PREINSTALLATION INSTRUCTIONS - FICHE À ASSOCIER AU TEXT DE PRE-INSTALLATION - DIESES DATENBLATT MUSS VOM VORINSTALLATIONS TEXT - FICHA A UNIRSE AL TEXTO DE PREINSTALACIÓN ПРИЛОЖИТЬ К ПРЕДВАРИТЕЛЬНОЙ ТЕКСТАМ**

 ~ 340 l	 ~ 260 l	 220-240 V 50/60 Hz 6 A 1,2 kW	 191x100x80 cm ~ 120 kg	 ~ 80 kg	 ~ 259 kg/m ²
---	--	---	--	---	--

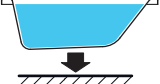
j-sha mi

SX

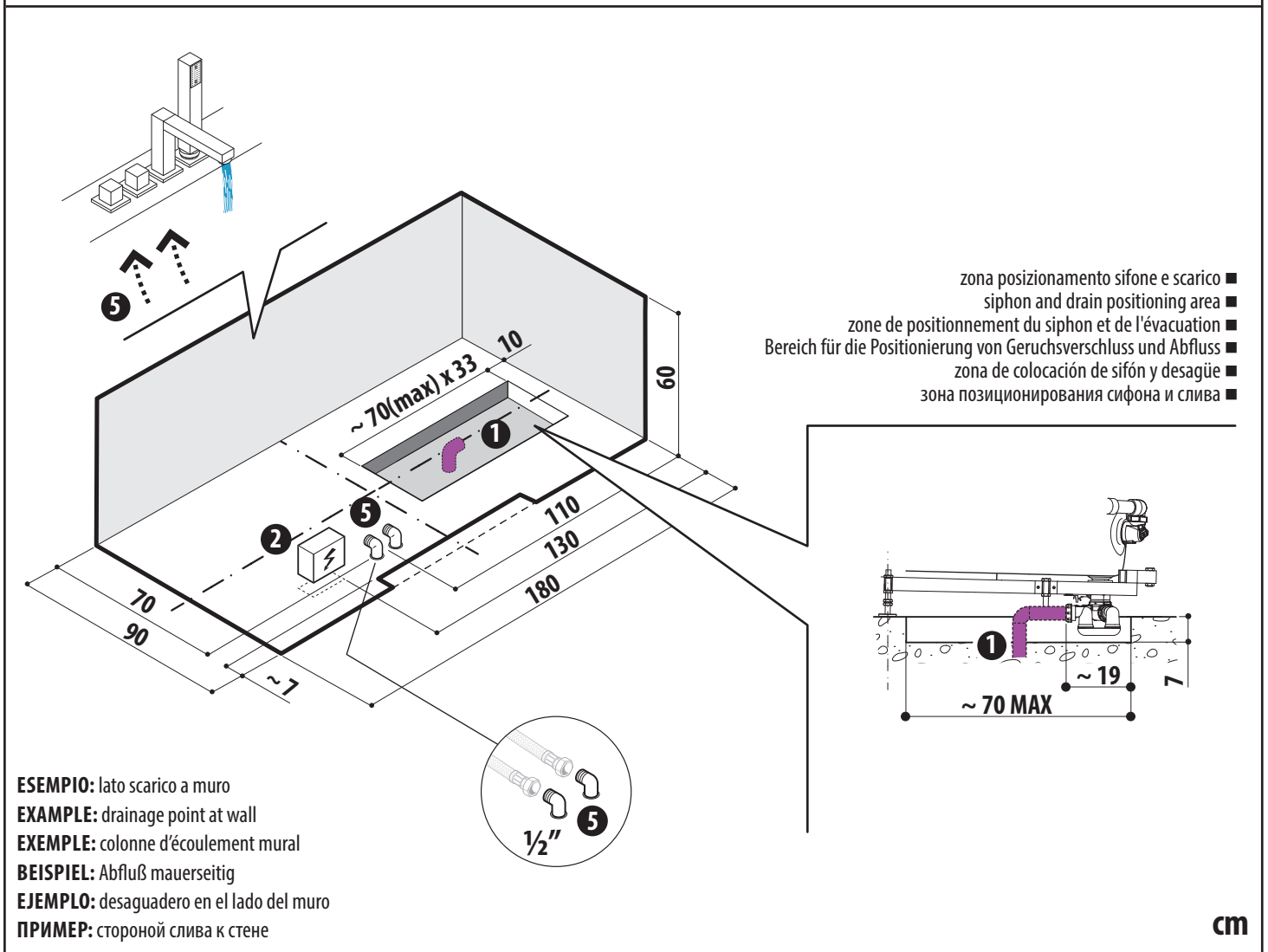
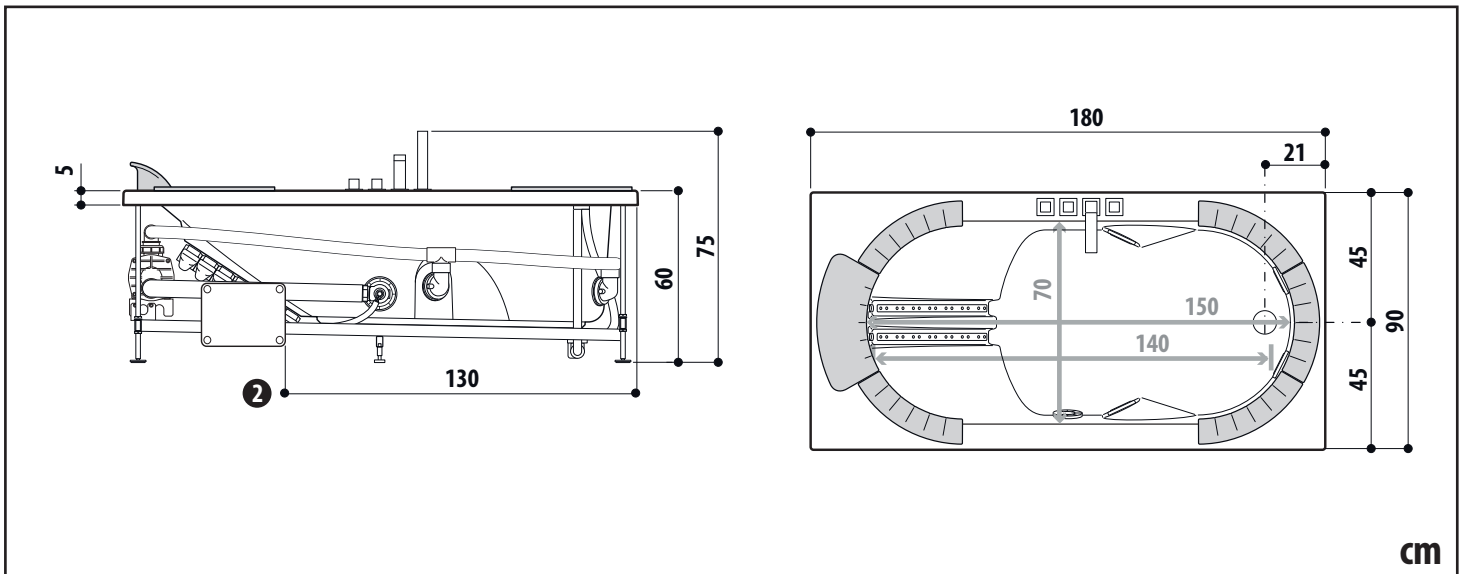

 **ALLEGARE IL TESTO DI PREINSTALLAZIONE - ADD TO THIS SHEET THE PREINSTALLATION INSTRUCTIONS - FICHE À ASSOCIER AU TEXT DE PRE-INSTALLATION - DIESES DATENBLATT MUSS VOM VORINSTALLATIONS TEXT - FICHA A UNIRSE AL TEXTO DE PREINSTALACIÓN ПРИЛОЖИТЬ К ПРЕДВАРИТЕЛЬНОЙ ТЕКСТАМ**