

Contento™ Technical Specifications

Letter	Description	Freestanding Soaking Bath Model
-	Drain Location	Center Drain
-	Cutout	N/A
-	Total Weight	997 lbs (452 kg)
-	Floor Loading	100.1 lb/ft2 (488.73 kg/m2)
-	Operating Gallons (Min/Max)	74 Gal. (280 L)
-	Product Weight	379 lbs (172 kg)
-	Soaking Depth	16-3/8" (415.9 mm)
L	Outer Length	59" (1498.6 mm)
W	Outer Width	32" (812.8 mm)
H	Overall Height	23" (584.2 mm)
A	Overflow Height	20-1/8" (511.1 mm)
B	Short Edge to Drain Center	11-13/16" (300 mm)
C	Long Edge to Drain Center	29-1/2" (749.3 mm)
D	Drain Shoe Length	N/A
E	Flange Height	N/A
F	Deck Width	3/4" (19.05 mm)
G	Service Access Dimensions	N/A
I	Floor Cutout for Drain	4" x 4" (101 x 101 mm)
J	Interior Dimensions J (L) x J (W)	56" x 23-1/4" (1422.4 mm x 590.55 mm)
M	Backrest Angle	68°

Key Dimensions

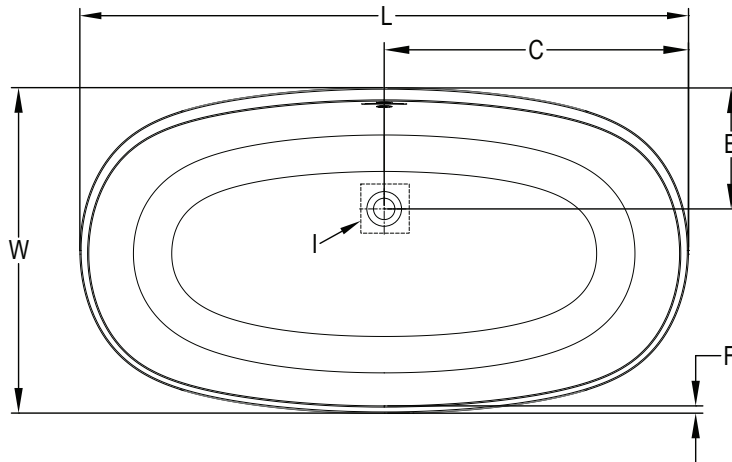

NOTE

The overall dimensions are nominal with a tolerance of +0 and -25" (6mm).

*Deck width reflects only area indicated on detail.

