

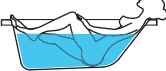

 ~ 355 l	 ~ 275 l	 220-240 V 50/60 Hz 6+6 (*) A 1,2+1,3 (*) kW	 190x100x81 cm + 194x104x26 cm ~ 130 + 90 kg	 ~ 100+43 kg	 ~ 307 kg/m ²
---	---	--	---	--	---

AURA UNO
CORIAN®



(*) con sistema di mantenimento della temperatura dell'acqua • with water temperature control system • avec système de maintien de la température de l'eau
mit system zur Erhaltung der Wassertemperatur • con sistema de mantenimiento de la temperatura del agua • с система поддержания температуры воды

DuPont™ e Corian® sono marchi commerciali registrati di E. I. du Pont de Nemours and Company o di sue società affiliate • DuPont™ and Corian® represent brand names registered by Pont de Nemours and Company or its affiliates • DuPont™ et Corian® sont marques commerciales enregistrées de E. I. du Pont de Nemours and Company ou de deux sociétés affiliées • DuPont™ und Corian® sind Handelsmarken, bzw. eingetragene Handelsmarke der E. I. du Pont de Nemours and Company oder deren Tochtergesellschaften • DuPont™ y Corian® son una marca comercial y una marca comercial registrada de E. I. du Pont de Nemours and Company o de sus sociedades afiliadas • DuPont™ и Corian® представляют собой торговые марки, зарегистрированные E. I. du Pont de Nemours and Company или ее дочерними компаниями.

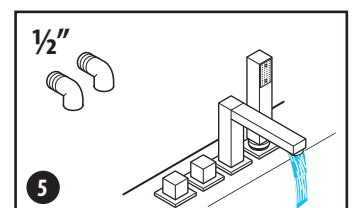
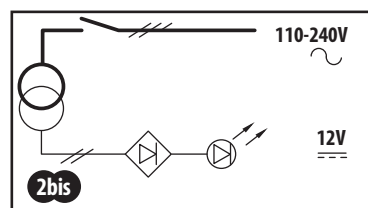
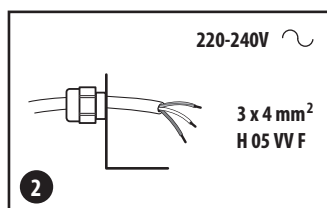
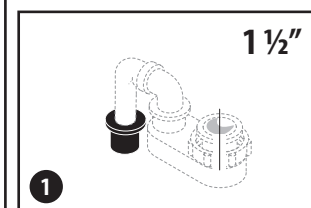
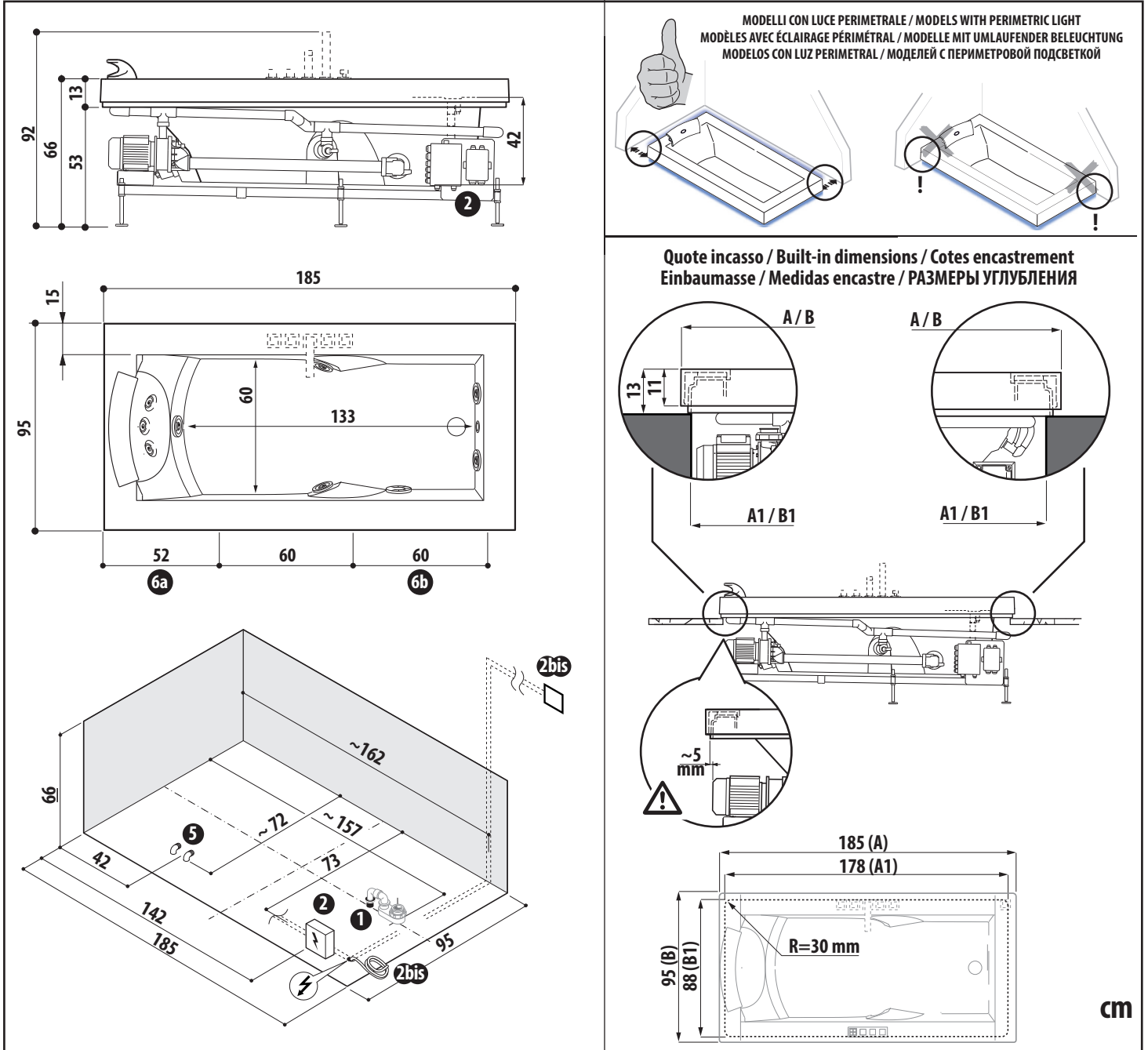

2BIS: TRASFORMATORE LUCI DA COLLEGARE, CON UN INTERRUPTORE BIPOLARE, ALL'IMPIANTO DELL'IMMOBILE / LIGHT TRANSFORMER TO BE CONNECTED, WITH A BIPOLAR SWITCH, TO THE SYSTEM OF THE BUILDING / TRANSFORMATEUR POUR ÉCLAIRAGE À RACCORDER AVEC UN INTERRUPTEUR BIPOLAIRE À L'INSTALLATION DE L'IMMEUBLE / TRANSFORMADOR DER BELEUCHTUNG ZUMANSCHLUSS AN DIE ANLAGE DES GEBÄUDES MIT EINEM ZWEIPOLIGEM SCHALTER / TRANSFORMADOR LUCES PARA CONECTAR, CON UN INTERRUPTOR BIPOLAR, A LA INSTALACIÓN DEL INMUEBLE / ТРАНСФОРМАТОР ОСВЕЩЕНИЯ, ПОДСОЕДИНЯЕМЫЙ С ДВУХПОЛЮСНЫМ ВЫКЛЮЧАТЕЛЕМ К СИСТЕМЕ ПОМЕЩЕНИЯ



ALLEGARE IL TESTO DI PREINSTALLAZIONE - ADD TO THIS SHEET THE PREINSTALLATION INSTRUCTIONS - FICHE À ASSOCIER AU TEXT DE PRE-INSTALLATION - DIESES DATENBLATT MUSS VOM VORINSTALLATIONS TEXT - FICHA A UNIRSE AL TEXTO DE PREINSTALACIÓN - ПРИЛОЖИТЬ К ПРЕДВАРИТЕЛЬНОЙ ТЕКСТАМ